

[PA 단열 슬라이딩] 230mm 이중창 두짝TYPE

[AUTO-LOCK ; 오토락]

No.	프레임폭	타입	유리사양	열관류율 (W/m²·K)	기밀성능 (m³/h·m²)
1-1	230 x 45	230mm 4-TRACK	24T : 5Low-E+14AR+5CL	0.896 (1등급)	0.82 (1등급)

[*로이유리사양은 고사양으로 SKN154II, MZT152 동등이상 제품 적용기준]

[AUTO-LOCK ; 오토락]

최소사이즈 (W) = 870

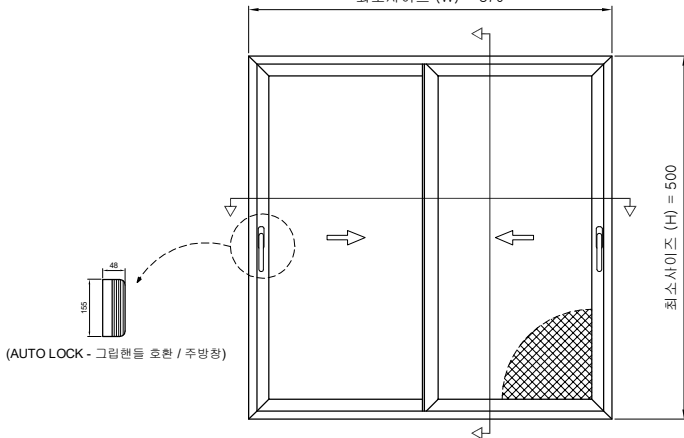

230SL - 이중창 ELEVATION

(INSIDE VIEW - 내관도 : A-TYPE)

최소사이즈 (W x H)	870 x 500	오토락 전용블러는 최대부담하중 60Kg/ EA이므로 최대허용중량의 범위 내에서 W, H의 사이즈를 검토
최대사이즈 (W x H)	문짝 중량에 따라 다름	

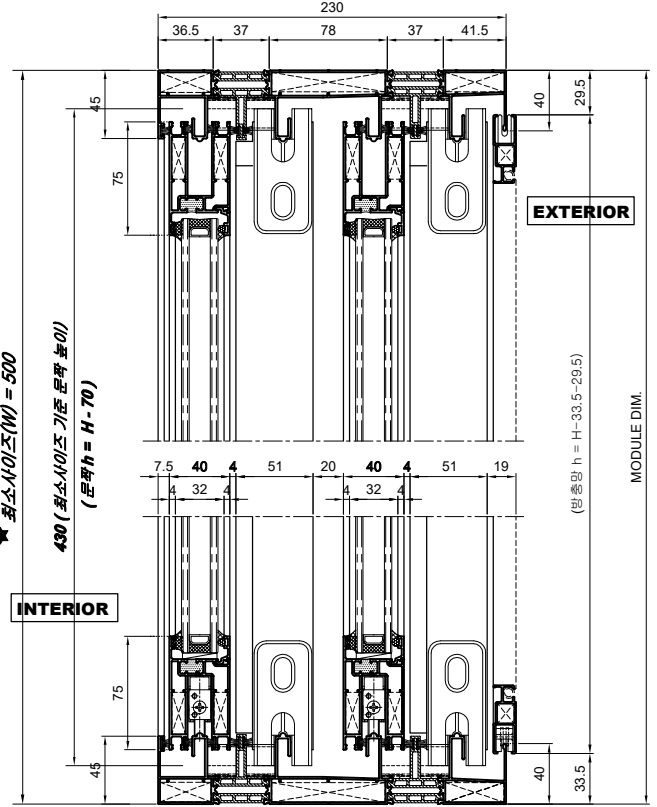

1 VERTICAL SECTION

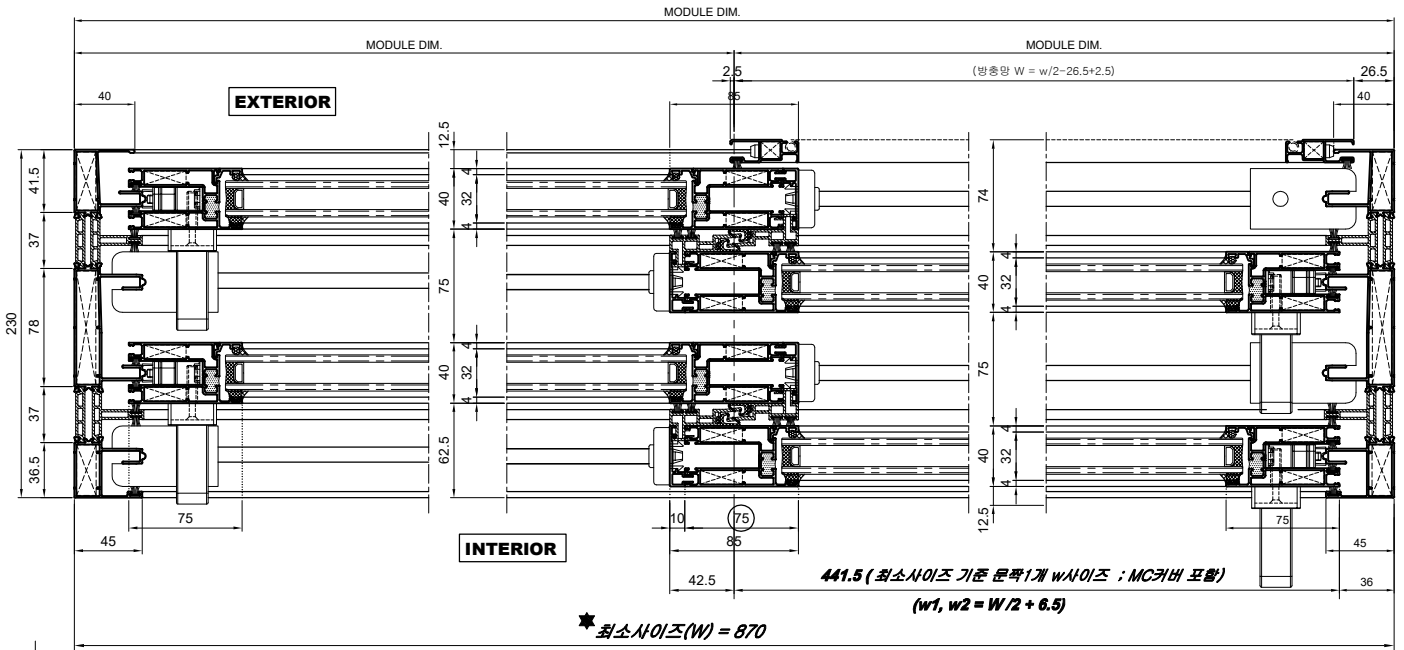

* 최소사이즈(W) = 870

2 HORIZONTAL SECTION

[PA 단열 슬라이딩] 230mm 이중창 두짝TYPE

[ALUMINUM EXTRUSION ; 압출재]

[AUTO-LOCK ; 오토락]

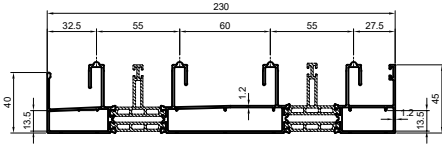

Dies No.	120SL11255	230SL11243	230SL11244
Weight	0.747 kg/m	1.195 kg/m	0.755 kg/m

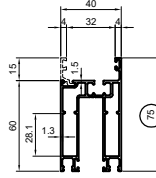

Dies No.	120SL15102
Weight	1.249 kg/m

오토락용 문짝 (크리센트 가능)

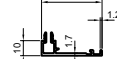

Dies No.	120SL19136
Weight	0.298 kg/m



Dies No.	120SL19137
Weight	0.125 kg/m

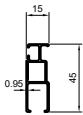

Dies No.	SCRO000077
Weight	0.328 kg/m

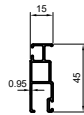

Dies No.	SCRO000076
Weight	0.343 kg/m

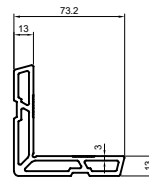

Dies No.	035PJ19105
Weight	2.462 kg/m

Frame 코너피스

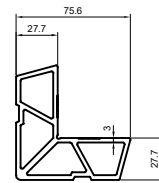

Dies No.	120SL19138
Weight	2.975 kg/m

Vent 코너피스

[ACCESSORY ; P-A, GASKET, HARDWARE]

■ PA, GASKET

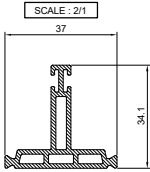

POLYAMIDE	
NO.	DS DSP-4907

(단열공정취부)

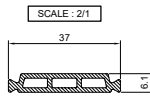

POLYAMIDE	
NO.	DS DSP-4906

(단열공정취부)

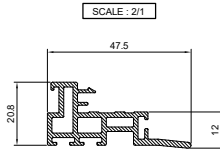

POLYAMIDE	
NO.	DS DSP-4908

(조립공정취부)



EPDM GASKET	
NO.	DS DS-E-1040

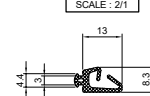

EPDM GASKET	
NO.	DS DS-E-1039

■ etc. ACCESSORY LIST

(오토락 / 정두짝 SL 1SET 기준)

No.	품명	업체명	제품 상세 내역 (SPEC.)	QTY	비고
1	M/C GUIDE	대동원테크	이탈방지스토퍼MC D형	8	오토락, 크리센트 공용
2	M/C AIR TIGHT	본사 구매	SL-E01/SL-E02 (A타입/B타입)	4	오토락, 크리센트 공용
3	FRAME AIR TIGHT (소)	세계사	풍지판 소 SL-280-E06	8	
4	FRAME STOPPER	대동원테크	BF스토퍼 - FS80 (블랙, 화이트)	4	오토락, 크리센트 공용
5	VENT STOPPER(120SL15103용)	대동원테크	SF스토퍼 37mm (오토락용)	8	
6-1	AUTO LOCK HANDLE(중형)	대동원테크	T6002 좌/우 (실버, 화이트)	1	H=1000이하
6-2	AUTO LOCK HANDLE(대형)		T6003 좌/우 (실버, 화이트)	1	H=1000이상
6-3	AUTO LOCK (GRIP) HANDLE		G6007 좌/우 (실버, 화이트)	1	(선택) 주방창용
7-1	AUTO LOCK KEEPER/STRIKE(1POINT)	대동원테크	이지오픈락-소형 16mm, 10mm레일용 스트라이크	4	H=1000이하
7-2	AUTO LOCK KEEPER/STRIKE(2POINT)		이지오픈락-대형 16mm, 10mm레일용 스트라이크	4	H=1000이상
8	ROLLER(120SL15103용)	쓰리지테크놀로지	130S(상글롤러-70Kg), 130T(트윈롤러-130Kg)	8	
9	방충망 조립구 (코너키)	본사 구매 및 병행	방충망 1SET당 4EA	4	
10	방충망 이탈방지		방충망 1SET당 2EA (상부)	2	
11	방충망 롤러		방충망 1SET당 2EA (하부)	2	