

# 150CW HIDDEN TYPE – FIX+PJ

규격별 성능 (고사양 유리 SKN154II, MZT152)

No	프레임폭	타입	유리사양	열관류율	기밀성능
1	150mm	FIX & PJ	24T [5로이+14아르곤+5일반]	1.278	1등급

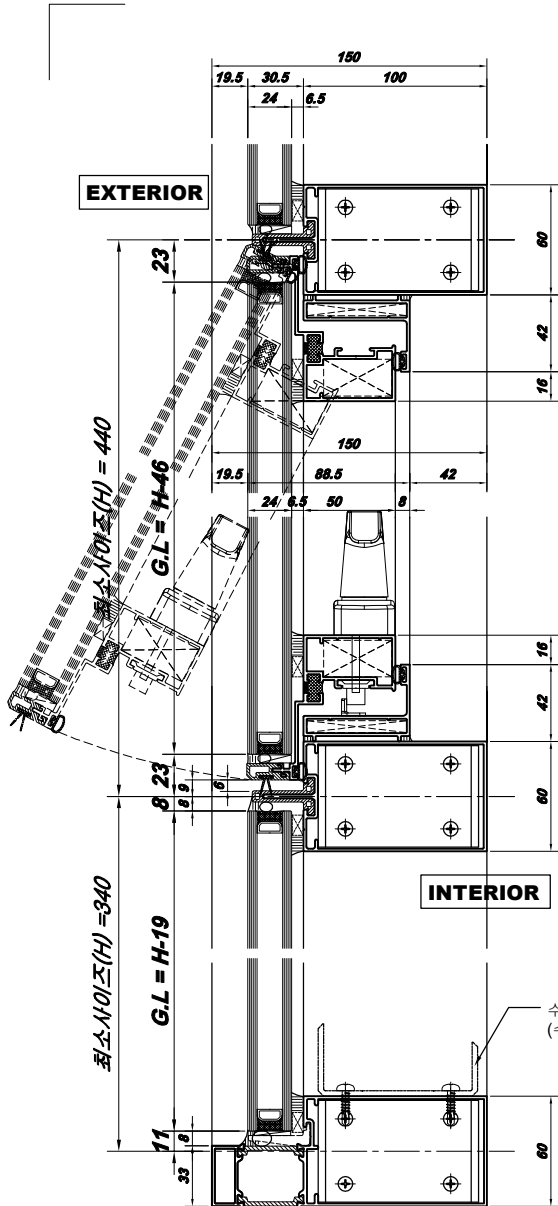

1 VERTICAL SECTION

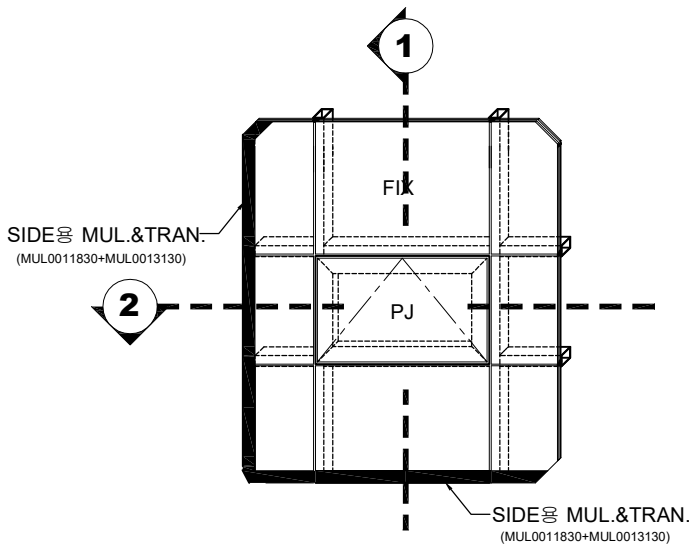

FIX & PROJECT ELEVATION  
(OUTSIDE VIEW)

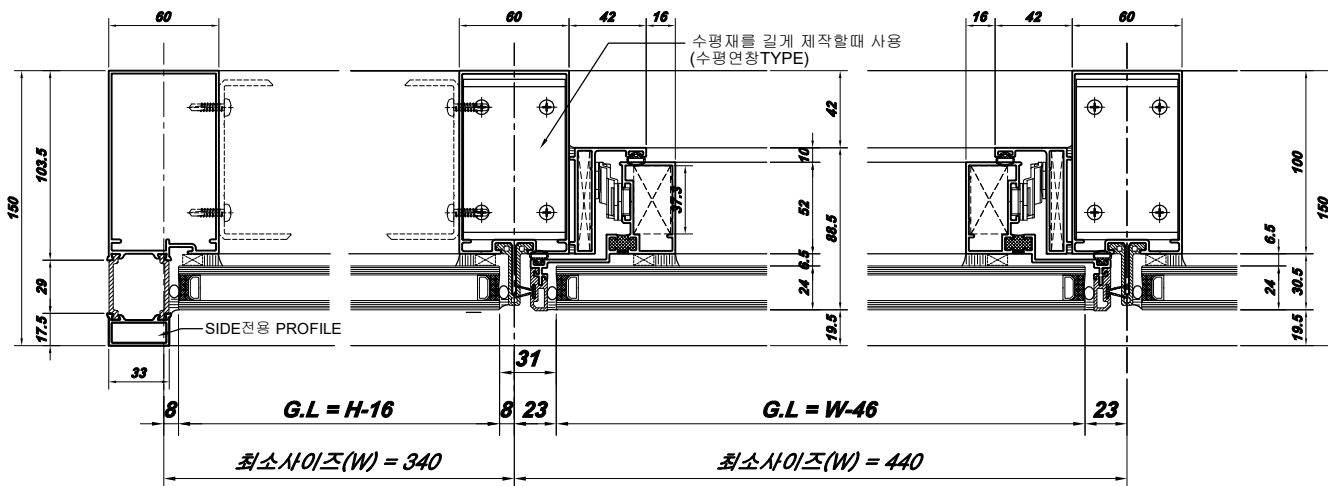

2 HORIZONTAL SECTION

# 150CW HIDDEN TYPE - FIX+PJ

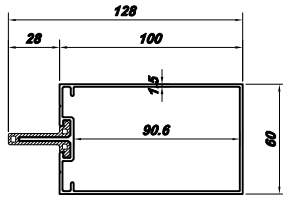

**MUL0011024 ★**  
THK 1.5  
1.602 kg/m

\* THICKNESS 에 따른  
음통 선택 OPTION

<b>MUL0010631</b> THK 1.8 1.838 kg/m	<b>MUL0011238</b> THK 2.0 1.942 kg/m
--	--

(SIDE 마감용 PROFILE)

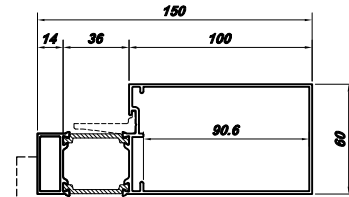

**MUL0011830 ★**  
THK 1.5  
0.430 kg/m

**MUL0013130 ★**  
THK 1.5  
1.491 kg/m

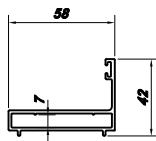

**MUL0010636 ★**  
THK 1.6  
0.769 kg/m

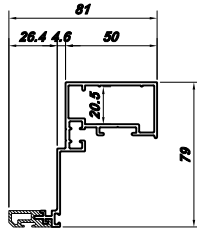

**MUL0011828 ★**  
THK 1.6  
1.179 kg/m

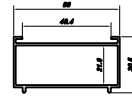

**MUL0009041 ★**  
THK 1.1  
0.543 kg/m

PJ 단독사용 Frame Attach

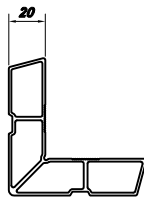

**MUL0013016**  
THK 1.5  
1.462 kg/m

(VENT용)

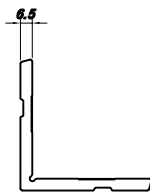

**035PJ19115 ★**  
THK 6.5  
2.263 kg/m

(VENT FRAME용)

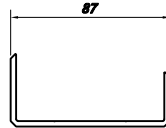

**MUL0011245 ★**  
THK 3.0  
1.179 kg/m

(CW BRACKET)

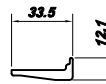

**MUL0005282 ★**  
THK 2.9  
0.436 kg/m

## PA, GASKET

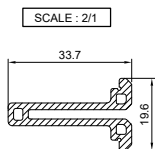

DSP-2532  
PA-721 ★  
IN-P-983

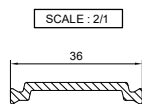

C-36  
C-36  
C-36

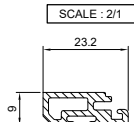

DSP-3174  
PA-944 ★  
IN-P-1115

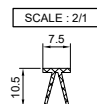

DS-E-059  
YJG-472  
TG-221

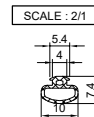

DSGA-181  
YJG-055  
OG-136

[동신테크 / 031-686-9860]  
[영진 / 031-366-9557]  
[인아웃택 / 031-357-9870]